



Interconnecting Elements

Features

Design

Standard Moduline dimensions :

Single pitch..... 70.6 mm (2.78 in)

Double pitch (only for union)..... 141.6 mm (5.57 in)

Triple pitch (only for union)..... 212.6 mm (8.37 in)

Various fitting configuration.

All tube conections are TIG orbital welded.

Materials

Wetted area..... 316L Stainless Steel

Rugosity..... electropolished, Ra0.15µm (6 µin)

Verification & Packaging

100% inspection with boroscope.

Vacuum sealed double packaging with N₂ purge.

Ratings

Specifications

Standard orifice size (internal)..... 4.5 mm (0.18 in)

High flow orifice size (internal)..... 6.5 mm (0.25 in)

Helium Leak Rate

Individually tested..... < 2.10⁻⁹ atm cm³/s

Union



Elbow



Tee



Cross



Jumper Cross



Dimensions

UNION

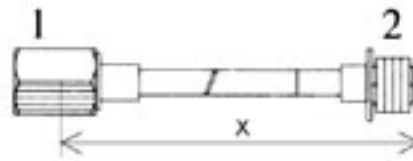

ULS, X = 70.6 mm
ULD, X = 141.8 mm
ULT, X = 212.6 mm

ELBOW

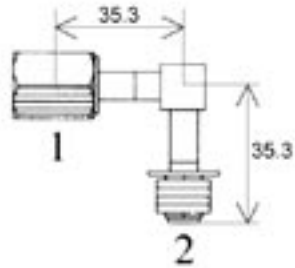

TEE

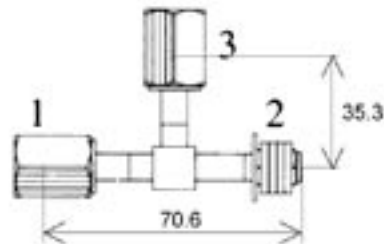

"Y"

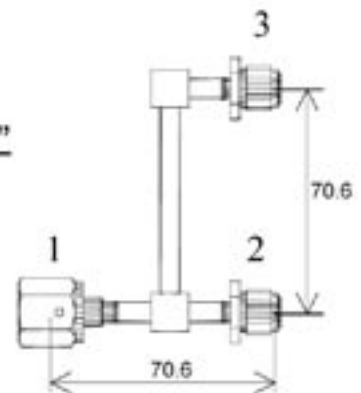

CROSS

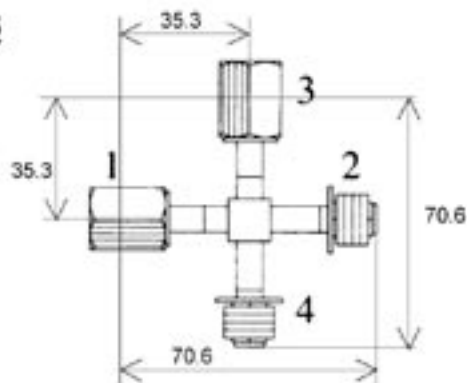

JUMPER CROSS

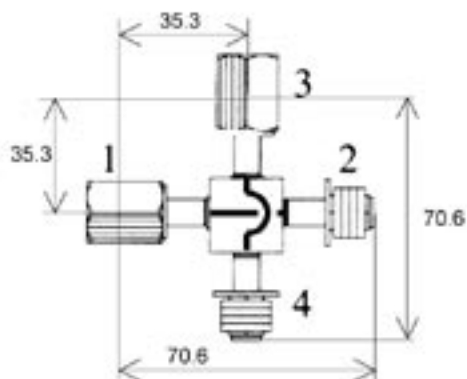

JUMPER CORNER CROSS

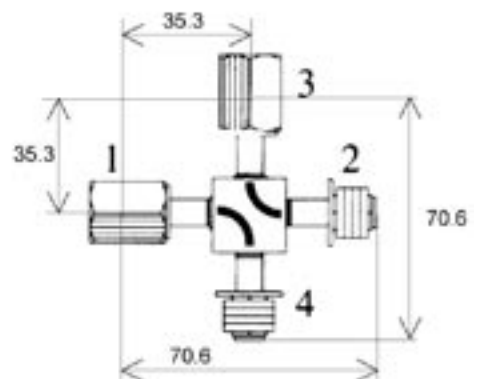

qualiflow therm



Accessories Series Interconnections

Part Number Description

Q [r , r][b , b][s][f] [1 , 2 , 3 , 4]

[r , r] - Flow Range

- [51] Standard flow
- [52] High flow

[b , b] - Body Configuration

- [01] Union - Moduline Single Pitch
- [53] Union - Moduline Double Pitch
- [54] Union - Moduline Triple Pitch
- [02] Elbow Element
- [05] Tee Element
- [96] "Y" Element
- [14] Jumper Cross Element
- [18] Jumper Corner Cross Element
- [26] Cross Element

[s] - Surface Finish

- [0] Q+ Process Electropolished Ra \square 0.15 μ m (6 μ in)

[f] - Fitting Configuration

- [1] Standard Moduline 1/4" VCR
- [2] Female 1/4" VCR
- [3] Standard Moduline 3/8" VCR (on request)
- [4] Swagelok 1/4"
- [5] Swagelok 3/8"
- [9] Other configurations, specify [1, 2, 3, 4]

[1,2,3,4] - Fitting Type

According to the element, choose fitting configuration and specify :

- [1,2] 2-way valve
- [1,2,3] 3-way valve
- [1,2,3,4] 4-way valve

Fitting list :

- [B] 1/4" VCR Female
- [C] 1/4" VCR Male
- [D] 3/8" VCR Female
- [E] 3/8" VCR Male
- [F] Swagelok 1/4"
- [G] Swagelok 6mm
- [H] Swagelok 3/8"
- [W] Welded butt ends